

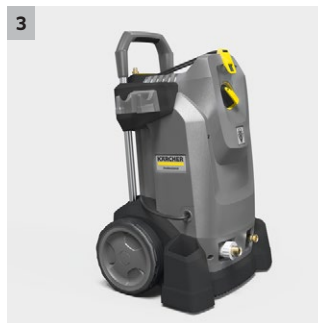

HD 6/11-4 M Plus

The HD 6/11-4 M Plus, a powerful, robust and versatile cold water pressure washer with good accessory storage and perfect manoeuvrability for daily operation.

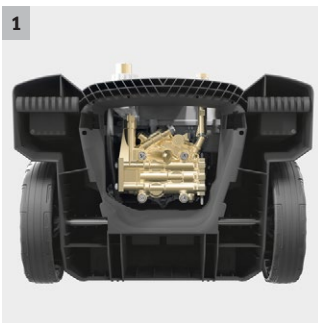
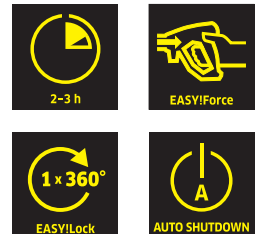

1 High-quality equipment

- Automatic pressure relief for protecting the components extends their service life.
- Powerful, 4-pole slow-running electric motor.

2 Flexible operation

- Designed for upright and horizontal operation.
- Maximum stability in horizontal operation as the wheels do not touch the ground.

3 Outstanding mobility

- Push handle can be retracted at the push of a button, thus increasing the compactness of the machine and reducing the space requirement.
- Effortless storage in service vehicles.

4 Clever accessory storage

- Bracket for fixing the cup foam lance.
- EASY!Lock TR20 allows the power nozzle or a surface cleaner to be stored directly at the machine.



HD 6/11-4 M Plus

- Robust 4-pole low-speed AC motor
- Save energy and time: EASY!Force high-pressure guns and EASY!Lock quick-release locks.
- Automatic pressure relief and up to 20 percent higher energy efficiency

Technical data

Order Number	1.524-938.0	
EAN code	4054278504933	
Current type	Ph / V / Hz	1 / 100 / 50
Flow rate	l/h	600
Operating pressure	bar / MPa	110 / 11
Max. pressure	bar / MPa	165 / 16,5
Max. water feed temperature	°C	60
Power rating	kW	2,9
Weight (with accessories)	kg	39
Dimensions (L x W x H)	mm	400 x 455 x 700

Equipment

Trigger gun	EASY!Force	
High-pressure hose	m	10 / Premium quality
Spray lance	mm	840
Power nozzle	■	
ANTI!Twist	-	
Pressure switch control	■	
Servo Control	-	

■ Included in delivery.

HD 6/11-4 M PLUS 1.524-938.0

KÄRCHER



		Order Number	ID	Max. working pressure	Length	Price	Description	
Standard with unions on both sides								
High-pressure hose, 10 m DN 8, AVS trigger gun connector	1	6.110-031.0	ID 8	315 bar	10 m		10 m high-pressure hose (M 22 x 1.5) with kink protection. With patented rotating AVS trigger gun connector and manual coupling. Further data: DN 8/155°C/315 bar.	▲
High-pressure hose, 15 m DN 8, AVS trigger gun connector	2	6.110-030.0	ID 8	315 bar	15 m		15 m high-pressure hose (M 22 x 1.5) with kink protection. With patented rotating AVS trigger gun connector and manual coupling. Further data: DN 8/155°C/315 bar.	▲
High-pressure hose, 20 m DN 8, AVS trigger gun connector	3	6.110-032.0	ID 8	315 bar	20 m		20 m high-pressure hose (M 22 x 1.5) with kink protection. With patented rotating AVS trigger gun connector and manual coupling. Further data: DN 8/155°C/315 bar.	▲
High-pressure hose, 30 m DN 8, including rotary coupling	4	6.110-014.0	ID 8	315 bar	30 m		With rotary coupling, 2 x M 22 x 1.5	▲
High-pressure hose, 15 m DN 10, 220 bar, extension	5	6.110-042.0	ID 10	220 bar	15 m		15 m high-pressure hose M 22 x 1.5) with kink protection and threaded couplings at both ends. Further data: DN 10/155°C/220 bar.	▲
High-pressure hose, 20 m DN 10, 220 bar, extension	6	6.110-043.0	ID 10	220 bar	20 m		with union on both sides, M 22 x 1.5 with anti-kink protection. NW 10/155°C/220 bar	▲
High-pressure hose, 25 m DN 10, extension, not rotatable	7	6.110-044.0	ID 10	220 bar	25 m			▲
Hose assembly premium DN10 22MPa 40m	8	6.110-045.0	ID 10	220 bar	40 m			▲
Hose assembly premium DN12 21MPa 15m	9	6.110-059.0	ID 12	210 bar	15 m		High-pressure hose for water volumes greater than 1,800 l/h. With union on both sides. 2x M 22 x 1.5 with anti-kink protection.	▲
Hose assembly premium DN12 21MPa 40m	10	6.110-060.0	ID 12	210 bar	40 m			▲
Hose assembly TR DN10 22MPa 10m	11	6.110-041.0	ID 10	220 bar	10 m			▲
High-pressure hose, 10 m DN 6, AVS trigger gun connector	12	6.110-034.0	ID 6	250 bar	10 m		10 m high-pressure hose (M 22 x 1.5) with kink protection.	□
	13	6.110-035.0	ID 6	250 bar	10 m		With patented rotating AVS trigger gun connector and manual coupling. Further data: DN 6/155°C/250 bar.	□
High-pressure hose, 10 m, DN 6, 300 bar, AVS trigger gun connection	14	6.110-056.0	ID 6	300 bar	10 m		With patented AVS connection in the trigger gun (pivot-mounted) and hand screw union. M 22 x 1.5 with anti-kink protection. NW 6/155°C/300 bar	□
Longlife 400 with unions on both sides								
High-pressure hose packaged	15	6.110-038.0	ID 8	400 bar	10 m		Durable, 10 m long high-pressure hose (ID 8) with double steel reinforcement and EASY!Lock hand screw connection at both ends and ANTI!Twist. Approved for 400 bar pressure.	▲
High-pressure hose Longlife 400, 30 m DN 8, including rotary coupling	16	6.110-023.0	ID 8	400 bar	30 m		With rotary coupling, 2 x M 22 x 1.5	▲
High-pressure hose Longlife 400, 20 m, DN 8, extension	17	6.110-027.0	ID 8	400 bar	20 m		with rotary coupling, 2 x M 22 x 1.5	▲
High-pressure hose Longlife 400, 15 m, DN 8, including rotary coupling	18	6.110-029.0	ID 8	400 bar	15 m		With rotary coupling, 2 x M 22 x 1.5	▲
High-pressure hose 1.5 m, DN 8, including connectors	19	6.110-024.0	ID 8	400 bar	1.5 m		1.5 m high-pressure hose (DN 8, M 22 x 1.5) with kink protection and connectors at both ends. For connecting to hose reels with appropriate connector (M 22 x 1.5).	□
Longlife 400 high-pressure hose, 1 x EASY!Lock, 1 x M22 x 1.5, DN 8, 400 bar, 1.5 m	20	6.110-069.0	ID 8	400 bar	1.5 m		High-pressure hose (ID 8) with double steel reinforcement, 1.5 m long, suitable for up to 400 bar pressure. Connectors: M 22 x 1.5, quick and convenient EASY!Lock hand screw connection.	□

■ Included in delivery. □ Available accessories. ▲ Extension hose.

HD 6/11-4 M PLUS

1.524-938.0

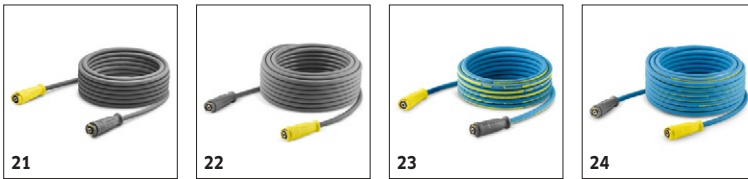

		Order Number	ID	Max. working pressure	Length		Price	Description	
Food industry version with unions on both sides									
High-pressure hose, 10 m ID 8, suitable for food industry, extension piece	21	6.110-051.0	ID 8	250 bar	10 m			10 m high-pressure hose (DN 8) with patented (rotating) AVS trigger gun connector. Non-discolouring outer layer for use in the food industry. M 22 x 1.5 with anti-kink sleeve.	<input type="checkbox"/>
High-pressure hose, 20 m ID 8, suitable for food industry, extension piece	22	6.110-052.0	ID 8	250 bar	20 m			20 m high-pressure hose (DN 8) with swivel coupling. Non-discolouring outer layer for use in the food industry. Connectors at both ends, M 22 x 1.5, with kink protection. NW 8/155°C/250 bar.	<input type="checkbox"/>
Longlife food industry version with unions on both sides									
High pressure hose food DN 8 / 10 m	23	6.110-053.0	ID 8	400 bar	10 m			Longlife HP hose for use in the food industry. Außendecke## animal-grease-resistant, non-colour-bleeding material. With rotary coupling, 2 x M 22 x 1,5	<input type="checkbox"/>
High-pressure hose Longlife 400, 15 m, ID 6, AVS trigger gun connection	24	6.110-054.0	ID 8	400 bar	20 m			Longlife HP hose for use in the food industry. Außendecke## animal-grease-resistant, non-colour-bleeding material. With patented AVS connection in the pistol (pivot mounted)	<input type="checkbox"/>

■ Included in delivery. □ Available accessories. ▲ Extension hose.

HD 6/11-4 M PLUS

1.524-938.0

KÄRCHER



		Order Number	Flow rate					Price	Description		
Trigger guns											
EASY!Force Advanced	1	4.118-005.0							Effortless, not energy-sapping: the EASY!Force high-pressure gun uses the recoil force of the high-pressure jet to reduce the holding force for the operator to zero.	■	
Conversion kit 1 from high pressure hose	2	4.111-050.0							A conversion kit which enables secure connection from an M22 hose onto our innovative EASY!Force trigger gun. The kit includes the EASY!Force Trigger gun, adaptors and lance.	□	
Conversion kit 2 from device	3	4.111-051.0							Provides all the parts required to utilise our EASY!Force technology even on our non-Easy!Force machines. Including adaptors, lance, Easy!Force trigger gun and hose.	□	
Conversion kit 3 only EASY!Force	4	4.111-052.0							A conversion kit for the EASY!Force gun, which includes the correct adaptors to connect to the M22 style lance and hose.	□	
Quick connect											
Quick-fitting pipe union coupler trapezo	5	2.115-000.0							For fast changes between different spray lances/accessories. Perfect for Kärcher spray unit, suitable for trigger gun/spray lance interface. With M 22 x 1.5 internal thread.	□	
Quick-fitting pipe union plug nipple tra	6	2.115-001.0							Hardened stainless steel male coupling for quick coupling 2.115-000. With M 22 x 1.5 external thread.	□	

■ Included in delivery. □ Available accessories. ▲ Extension hose.

HD 6/11-4 M PLUS

1.524-938.0

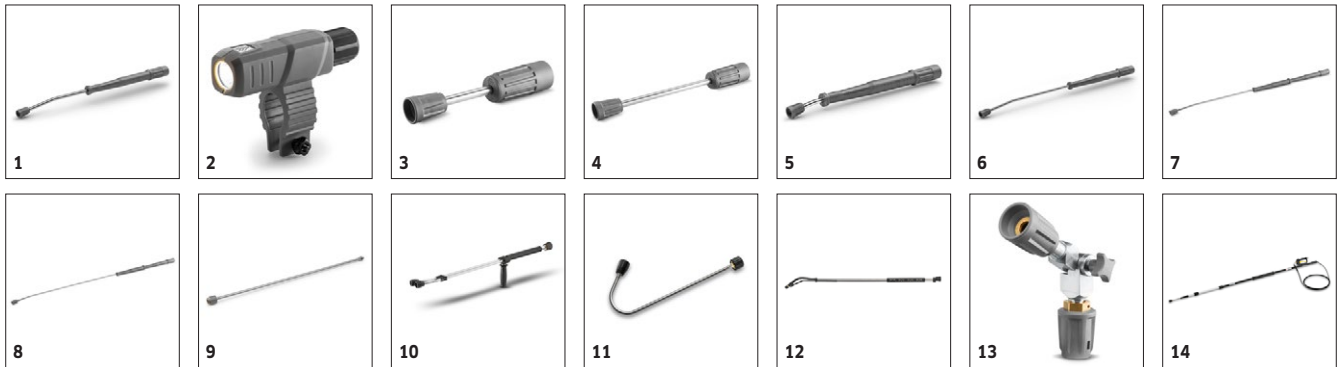

		Order Number	Max. working pressure	Length		Price	Description	
Rotating spray lances								
Lance 850 mm, rotatable, ergonomic	1	4.112-006.0	300 bar	840 mm			850 mm stainless steel lance (manual coupling) with ergonomic handle for ease of use and protection. Rotatable 360° under pressure.	■
Nozzle Light	2	2.680-002.0		125 mm			LED work light for assembly on EASY!Force spray lances, providing a clear view in poor lighting conditions ensuring controlled cleaning results.	□
Lance 250 mm, non-rotatable	3	4.112-027.0	300 bar	250 mm			600 mm stainless steel lance (manual coupling) with ergonomic handle for ease of use and protection. Rotatable 360° under pressure.	□
550 mm lance, non-rotatable	4	4.112-024.0	300 bar	400 mm				□
Rotatable lance, 600 mm, ergonomic	5	4.112-007.0	300 bar	600 mm				□
1050 mm lance, rotatable, ergonomic	6	4.112-000.0	300 bar	1050 mm			1050 mm stainless steel lance (manual coupling) with ergonomic handle for ease of use and protection. Rotatable 360° under pressure.	□
Lance 1550 mm, rotatable, ergonomic	7	4.112-018.0	300 bar	1550 mm			1550 mm stainless steel lance (manual coupling) with ergonomic handle for ease of use and protection. Rotatable 360° under pressure.	□
Lance 2050 mm, rotatable, ergonomic	8	4.112-021.0	300 bar	2050 mm			2050 mm stainless steel lance (manual coupling) with ergonomic handle for ease of use and protection. Rotatable 360° under pressure.	□
Jet pipe extension TR 1000 mm	9	4.112-048.0	300 bar	1000 mm			Spray lance extension with EASY!Lock connection. Length 1000 mm.	□
Double lance								
Double lance 960 mm	10	2.112-016.0	310 bar	960 mm			960 mm double lance for variable pressure adjustment on handle at full water flow rate. Suitable for agricultural use (e.g. stable cleaning).	□
Angular spray lance								
WC and gutter lance	11	4.112-029.0					Stainless steel lance WC and gutter with nozzle insert. Specially shaped for effective and hygienic cleaning of gutters and toilets.	□
Flexible spray lance								
Flexible lance 1050 mm	12	4.112-035.0	210 bar	1050 mm			1050 mm flexible lance with variable bend from 20° to 140°, ideal for cleaning difficult to reach areas, e.g. gutters.	□
Articulated joint TR 20	13	4.112-057.0	300 bar				For hard-to-reach areas: High-pressure articulated joint with infinite angle adjustment up to 120°. Simply attach directly to the spray lance of the pressure washer.	□
Telescopic spray lance								
Telescopic jet pipe	14	4.112-037.0	225 bar	5400 mm			Can be continuously extended from 1.8 to 5.4 m. For cleaning areas that are difficult to reach, such as ceilings or facades. With integrated HD trigger gun, M 22 x 1.5 connection with rotary coupling. Connection for M 18 x 1.5 nozzles.	□
Restraint belt for telescopic jet pipe	15	6.373-987.0					Convenient strap for relief when working with the telescopic spray lance (6.394-690). The burden is optimally distributed on the body and longer periods of use are possible.	□
Gutter cleaner								
Gutter cleaning lance	16	2.112-015.0		960 mm			The lance is suited for cleaning of gutter systems. Because of the shape of the lance and the special nozzle the gutter can be cleaned without removing the cover plates.	□
Undercarriage spray lance								
Underbody lance	17	4.112-032.0		700 mm			Stainless steel lance for effective and easy underbody and wheel arch cleaning. Without high-pressure nozzle.	□

■ Included in delivery. □ Available accessories. ▲ Extension hose.

HD 6/11-4 M PLUS

1.524-938.0



			Order Number	Max. working pressure	Length			Price	Description	
Additional handle										
Additional handle for EASY!Lock spray lances	18	4.321-380.0							Comfortable in every situation - the additional handle is easy to attach to the spray lance of our new EASY!Lock generation and makes work easier by allowing you to adjust your posture to suit the particular task.	<input type="checkbox"/>
PowerControl spray lance										
PowerControl spray lance 042	19	4.112-046.0							Our PowerControl spray lance with nozzle size 042 makes possible the appropriate cleaning performance for each cleaning task. Infinitely variable and precise pressure adjustment directly within reach.	<input type="checkbox"/>

■ Included in delivery. □ Available accessories. ▲ Extension hose.

HD 6/11-4 M PLUS

1.524-938.0



		Order Number	Max. working pressure	Nozzle size		Price	Description	
Dirt blaster, large								
Dirt blaster - without changeover function	1	4.114-042.0	300 bar	45			The dirt blaster with rotating pencil jet offers 10 times better cleaning performance. Ceramic nozzle and bearing ring for a long service life. Further data: Max. 300 bar, 30 MPa, 85°C.	■
Dirt Blaster, small								
Dirt blaster, small 045	2	4.114-021.0	180 bar	45			Up to 50% higher cleaning and area performance than its predecessor: with the new performance dirt blaster (nozzle size 045), power losses have been minimised and the spray quality maximised.	□
Triple nozzles								
Triple nozzle 042	3	4.117-034.0	300 bar	42			Triple nozzle with manual nozzle changeover. Convenient spray adjustment. For high-pressure cleaners with injector; low-pressure fan jet for detergent removal and application. Connector M 18x1.5.	□
Triple jet nozzle 045	4	4.117-036.0	300 bar	45			Triple nozzle with manual nozzle changeover. Convenient spray adjustment. For machines with an injector, the low-pressure flat stream is useful for cleaning agent suction and application. Connection M 18 x 1.5.	□
Angle vario nozzle 0°-90°								
Spezial nozzle 0005	5	4.113-007.0		50			Variable angle nozzle for spray angle adjustment from 0° to 90°. For easy adjustment to all kinds of soiling and surfaces.	□

■ Included in delivery. □ Available accessories. ▲ Extension hose.

HD 6/11-4 M PLUS

1.524-938.0



1-4

		Order Number	Nozzle size					Price	Description	
Power nozzle spray angle 25°										
Power nozzle spray angle 25°	1	2.113-022.0	45						Fan jet nozzle with 25° spray angle, suitable for large areas and removing stubborn dirt and stains.	■
HP nozzle spray angle 0°										
High-pressure nozzle spray angle 0°	2	2.113-033.0	45						High-pressure nozzle with powerful jet for extremely stubborn dirt.	□
Power nozzle spray angle 15°										
Power nozzle spray angle 15°	3	2.113-046.0	45						Fan jet nozzle with 15° spray angle suitable for stubborn dirt.	□
Power nozzle spray angle 40°										
Power nozzle spray angle 40°	4	2.113-053.0	45						Power nozzle with a 40° spray angle and fan jet, suitable for large areas and sensitive surfaces.	□

■ Included in delivery. □ Available accessories. ▲ Extension hose.

HD 6/11-4 M PLUS 1.524-938.0



		Order Number						Price	Description
Adapter 6 TR22IG-M22AG	19	4.111-034.0							Adapter 6 to connect the new device with the old hose and the old hose with the new gun <input type="checkbox"/>
Adapter 7 M18IG-TR20AG	20	4.111-035.0							Adapter 7 to connect the old spray lance with the new nozzle <input type="checkbox"/>
Adapter 8 TR20IG-M18AG	21	4.111-036.0							Adapter 8 to connect the new spray lance with the old nozzle <input type="checkbox"/>
ADAPTER for replacement TR22IG-M22AG Er	22	4.111-046.0							Rotatable adapter for connecting EASY!Force high-pressure gun and high-pressure hoses with M 22x1.5 connection <input type="checkbox"/>

■ Included in delivery. □ Available accessories. ▲ Extension hose.

HD 6/11-4 M PLUS

1.524-938.0

KÄRCHER



		Order Number	Max. working pressure	Nozzle size	Diameter		Price	Description	
Pipe cleaning hose, ID 6									
Hose assembly TR pipe cleaning DN6 max.2	1	6.110-046.0	250 bar					The 10 m pipe cleaning hose is a highly flexible high pressure hose for pipe interior cleaning (threaded connection for nozzle R 1/8).	<input type="checkbox"/>
Pipe cleaning hose, DN 6, 20 m, 220 bar	2	6.110-008.0	250 bar					20 m flexible high-pressure hose (DN 6) for cleaning pipes up to 220 bar (threaded connection for R 1/8 nozzle).	<input type="checkbox"/>
Hose assembly TR pipe cleaning DN6 max.2	3	6.110-047.0	250 bar					The 30 m pipe cleaning hose is a highly flexible high pressure hose for pipe interior cleaning (threaded connection for nozzle R 1/8).	<input type="checkbox"/>
Hose assembly TR pipe cleaning DN6 14MPa	4	6.110-048.0	140 bar					10 m flexible high-pressure hose (DN 6) for cleaning pipes (threaded connection for R 1/8 nozzle).	<input type="checkbox"/>
Pipe cleaning hose	5	6.110-049.0	140 bar					20 m flexible high-pressure hose (DN 6) for cleaning pipes (threaded connection for R 1/8 nozzle).	<input type="checkbox"/>
Pipe cleaning hose, DN 6, 30 m	6	6.110-050.0	140 bar					30 m flexible high-pressure hose (DN 6) for cleaning pipes (threaded connection for R 1/8 nozzle).	<input type="checkbox"/>
Pipe cleaning nozzle									
Dirt blaster pipe cleaning D21/040	7	4.765-001.0		40	21 mm			The forward-tilted rotating pencil jet removes the most stubborn dirt. The three backwards-tilted jets ensure the necessary forward movement, as well as convenient handling.	<input type="checkbox"/>
Dirt blaster pipe cleaning D30/040	8	4.765-004.0		40	30 mm				<input type="checkbox"/>
Pipe cleaning nozzle	9	5.763-015.0		55	16 mm			16 mm pipe cleaning nozzle with internal thread. Various jet directions for environmentally-friendly cleaning of blocked drains and pipes.	<input type="checkbox"/>
	10	5.763-016.0		60	16 mm				<input type="checkbox"/>
	11	5.763-017.0		50	30 mm				30 mm pipe cleaning nozzle with internal thread. Various jet directions for environmentally-friendly cleaning of blocked drains and pipes.
Rotating pipe cleaning nozzle	12	6.415-428.0		50	16 mm			Rotating pipe cleaning nozzle with internal thread and four rotating jets for environmentally-friendly cleaning of blocked drains and pipes.	<input type="checkbox"/>

■ Included in delivery. □ Available accessories. ▲ Extension hose.

HD 6/11-4 M PLUS

1.524-938.0

KÄRCHER



		Order Number	Flow rate	Nozzle size	Diameter	Price	Description	
Hard Surface Cleaner FRV 30								
Add-on kit rubber lip	1	2.642-910.0					For smooth floors indoors. The squeegee increases the suction performance of the FRV 30 and minimises the amount of water remaining. This means the floor is dry in just a few minutes.	<input type="checkbox"/>
Extension hose 5 m	2	4.440-939.0					5m extension hose for FRV 30. Connection sleeve included.	<input type="checkbox"/>
Add-on kit hose attachment	3	2.642-528.0					Suction cup for fixing the suction hose to smooth surfaces.	<input type="checkbox"/>
Add-on kit dirt trap	4	2.642-532.0					Galvanised steel bucket for collecting coarse dirt and for fixing the suction hose in outside areas.	<input type="checkbox"/>
FRV 30	5	2.111-010.0					Surface cleaner with integrated waste water pick-up	<input type="checkbox"/>
Hard surface cleaner FR 30								
FR 30 Surface Cleaner	6	2.111-011.0			300 mm		Up to 10 times greater area coverage compared with the conventional high pressure jet.	<input type="checkbox"/>
Hard surface cleaner FR 30 ME								
FR 30 ME surface cleaner	7	2.111-013.0			300 mm		Hot water resistant stainless steel surface cleaner with double ceramic bearings, non-marking swivel castors and suction hose connection. Ideal for indoor cleaning, e.g. food industry.	<input type="checkbox"/>
Machine-specific nozzle kit for FR								
Nozzle kit for surface cleaners (type-specific) 650 - 850 l/h	8	2.639-187.0	650-850 l/h				Nozzle kit includes power nozzles and unions. For Kärcher surface cleaners (650 to 850 l/h).	<input type="checkbox"/>
Machine-specific nozzle kits for FRV								
Nozzle kit 045 - for FRV	9	2.642-432.0		45			Machine-specific nozzle kit with Kärcher power nozzles and jet nozzle for FRV 30.	<input type="checkbox"/>
Hard surface cleaner FRV 30 Me								
Extension hose FRV 30 Me and FRV 50 Me	10	4.441-040.0					5 m extension hose for FRV 30 Me. Includes connecting adapter.	<input type="checkbox"/>
FRV 30 Me Surface Cleaner	11	2.111-012.0					Thanks to automatic suction of the dirty water, the stainless steel FRV 30 Me Surface Cleaner makes surface cleaning more efficient in both inside and outside areas. Hot water cleaning up to 85°C.	<input type="checkbox"/>

■ Included in delivery. □ Available accessories. ▲ Extension hose.

HD 6/11-4 M PLUS

1.524-938.0

KÄRCHER



		Order Number	Flow rate				Price	Description	
Cup foam lance									
Cup foam lance Basic 2	1	4.112-054.0	700-800 l/h					For high-pressure cleaners with a flow rate of 700-800 l/h: new, robust and very high-quality foam cup lance with outstanding foam quality while consuming half as much cleaning agent.	<input type="checkbox"/>
Cup foam lance Advanced 042	2	2.112-018.0						Short, handy foam lance with adjustable spray angle with 1 litre detergent tank. Ideal for cleaning cars due to its compact design.	<input type="checkbox"/>
Tank grey only for replacement 1L	3	6.414-050.0						Additional 1-litre cleaning agent container for quick replacement of the cleaning agent (for foam lance 2.112-017.0 and 2.112-018.0).	<input type="checkbox"/>
Inno Foam Set									
Inno foam kit with detergent injector	4	2.112-000.0						High-pressure foam system with double lance (foam nozzle and high-pressure jet for rinsing). For use with mobile and stationary high-pressure and HDS pressure cleaners for cleaning or disinfection.	<input type="checkbox"/>
Easy Foam Set									
Easy Foam Set with RM injector	5	2.112-010.0						HP foam system for use with HD/HDS units for cleaning and disinfecting. Foam nozzle for connection to lance and HP chemical injector with precision 0-5% metering valve. The machine specific nozzle kit has to be ordered separately.	<input type="checkbox"/>
Nozzle kits for Inno/Easy Foam Set									
Nozzle kit 055 z. Inno/Easy Set 500 - 600 l/h	6	2.111-009.0	500-600 l/h					Optimal adaptation to different machine outputs for economic use.	<input type="checkbox"/>
Foam nozzle mounting kit									
Foam nozzle kit	7	2.112-013.0						Foaming agent kit. The foam nozzle is ideal for use in sanitary areas and the food industry and wherever long application times are necessary.	<input type="checkbox"/>

■ Included in delivery. □ Available accessories. ▲ Extension hose.

HD 6/11-4 M PLUS

1.524-938.0

KÄRCHER



		Order Number	Length				Price	Description	
Hose reel add-on kit									
Add-on kit hose reel module	1	2.110-024.0	15 m					Hose reel attachment kit for high-pressure middle class	<input type="checkbox"/>
Automatic, self-winding hose reels									
Wall-mounted hose reel	2	2.639-257.0	15 m						<input type="checkbox"/>
Add-on kit hose reel plastics	3	6.392-074.0	20 m					Automatic hose reel for 20 m high-pressure hose. The console is made from powder-coated steel, the drum is made from plastic.	<input type="checkbox"/>
Add-on kit hose reel	4	6.392-083.0	20 m					Automatic hose reel for 20 m high-pressure hose. The console consists of stainless steel, the drum is made from plastic.	<input type="checkbox"/>
Hose reel, automatic, 20 m, painted	5	6.392-106.0	20 m					Automatic hose reel of durable plastic. Painted steel bracket. Suitable for 20 m high-pressure hose.	<input type="checkbox"/>
Hose reel, automatic, basalt grey-coated	6	6.392-105.0	20 m					Automatic hose reels provide the highest level of safety and convenience for winding and unwinding HP hoses.	<input type="checkbox"/>
Hose reel, automatic, 20 m, stainless steel	7	6.392-076.0	20 m					Automatic stainless steel hose reel. With swivel holder. Suitable for 20 m high-pressure hose.	<input type="checkbox"/>
ABS hose reel stainless steel	8	6.392-122.0	20 m					High-grade, automatic steel hose reel. Especially suitable for use in the food industry. The material and finish provide for a corrosion-resistant, watertight capsuled sprong drive. Connection for HP hoses with nipple.	<input type="checkbox"/>
Add-on kit hose reel TR 40m	9	6.392-442.0	40 m					Automatic hose reels provide the highest level of safety and convenience for winding and unwinding HP hoses. Compatible high-pressure hose, e.g. order no. 6.110-076.0 (ID 8, 40 m, 400 bar, 1x hose reel connection attachment kit).	<input type="checkbox"/>
Swivel holder	10	2.639-931.0						Swivel holder for automatic hose reel wall mounting. For maximum action radius and flexibility of high-pressure hose. Rotatable 120°. Galvanised steel.	<input type="checkbox"/>
ABS wall fastening stainless steel	11	2.641-867.0						Swivelling wall bracket made of high-grade steel (for 2.641-866). This makes maximum flexibility and convenience possible when working with the HP hose.	<input type="checkbox"/>

■ Included in delivery. □ Available accessories. ▲ Extension hose.

HD 6/11-4 M PLUS

1.524-938.0

KÄRCHER

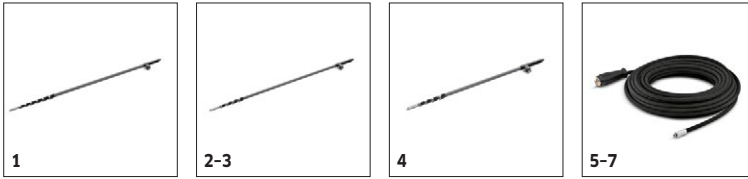

		Order Number	Flow rate	Water feed temperature	Length	Length	Price	Description	
Solar cleaning - telescopic lances									
Telescopic rod complete 14m	1	4.110-002.0		max. 60 °C				Full carbon telescopic rod for maximum rigidity with minimal weight. With 14 m max. reach and practical quick-release couplings for easy extension and retraction.	<input type="checkbox"/>
Telescopic rod complete 10m CFK	2	4.110-007.0		max. 60 °C				The full carbon telescopic lance offers maximum rigidity with minimal weight. It has a reach of up to 10 m and is fitted with practical quick-release couplings - for convenient extension and retraction.	<input type="checkbox"/>
Telescopic rod complete 10m	3	4.110-003.0		max. 60 °C				Telescopic rod made from a carbon/fibreglass mixture for maximum rigidity with minimum weight. With 10 m max. reach and practical quick-release couplings for easy extension and retraction.	<input type="checkbox"/>
iSolar TL 7 H (without hose)	4	4.110-004.0		max. 60 °C				Telescopic rod made from a carbon/fibreglass mixture for maximum rigidity with minimum weight. With 7.2 m max. reach and practical quick-release couplings for easy extension and retraction.	<input type="checkbox"/>
Hose solar	5	6.392-978.0		max. 155 °C				High-quality, flexible HP hose (with rubber covering) for the iSolar TL 7. The outer layer has especially good sliding properties when extending and retracting the telescopic rod.	<input type="checkbox"/>
	6	6.392-977.0		max. 155 °C				High-quality, flexible HP hose (with rubber covering) for the iSolar TL 10. The outer layer has especially good sliding properties when extending and retracting the telescopic rod.	<input type="checkbox"/>
	7	6.392-976.0		max. 155 °C				High-quality, flexible HP hose (with rubber covering) for the iSolar TL 14. The outer layer has especially good sliding properties when extending and retracting the telescopic rod.	<input type="checkbox"/>

■ Included in delivery. □ Available accessories. ▲ Extension hose.

HD 6/11-4 M PLUS

1.524-938.0



		Order Number	Nozzle size				Price	Description	
Wet blasting attachment (without nozzle)									
Wet blasting attachment with flow control (without nozzles)	1	4.115-000.0						Paint, rust and scale removal made easy: Kärcher wet blasting attachment with flow control for adding blasting abrasive to the high-pressure jet.	<input type="checkbox"/>
Wet blasting attachment without flow control (nozzles not included)	2	4.115-006.0						Paint, rust and scale removal made easy: Kärcher wet blasting attachment with flow control for adding blasting abrasive to the high-pressure jet. Without flow control.	<input type="checkbox"/>
Nozzle pack for wet blasting attachment									
Nozzle pack TR wet jet set 0045	3	2.112-022.0	45					Nozzle kit with wet blasting nozzle and nozzle insert (type specific). For optimal Kärcher wet blasting attachment performance. Only in combination with wet blasting attachment 4.115-000.0 4.115-006.0.	<input type="checkbox"/>
Boron carbide nozzle									
Boron carbide nozzle, for machines as of 1000 l/h	4	6.415-084.0	6 mm					In addition to nozzle packs. Very wear-resistant nozzle with boron carbide chuck for continuous-duty operation.	<input type="checkbox"/>

■ Included in delivery. □ Available accessories. ▲ Extension hose.

HD 6/11-4 M PLUS

1.524-938.0

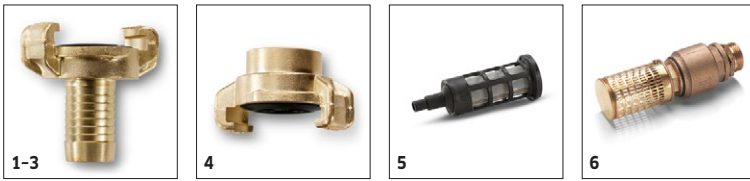

		Order Number		Price	Description	
Geka coupling						
With hose nozzle, R 1/2"	1	6.388-461.0			with hose liner	<input type="checkbox"/>
With hose nozzle, R 3/4"	2	6.388-455.0			with hose liner	<input type="checkbox"/>
With hose nozzle, R 1"	3	6.388-465.0			with hose barb	<input type="checkbox"/>
With female thread, R 3/4"	4	6.388-473.0			with female thread	<input type="checkbox"/>
Suction filter						
Water filter	5	6.414-956.0			Suitable for ponds, storage tanks or similar, polyamide filter casing, stainless steel strainer, 800 µm mesh, R 3/4" and R 1" connection, without non-return valve	<input type="checkbox"/>
Suction filter with check valve	6	4.730-012.0			Brass suction filter suitable for ponds, storage tanks, etc. With check valve.	<input type="checkbox"/>

■ Included in delivery. □ Available accessories. ▲ Extension hose.

HD 6/11-4 M PLUS 1.524-938.0



		Order Number		Price	Description	
Fine-mesh water filter						
Fine-mesh water filter, 100 µm, R 3/4"	7	2.637-691.0			Fine-mesh water filter, 100 µm, max. temperature 60°C. Protects the high-pressure cleaner from dirt particles contained in the water. Transparent filter cup. Water flow rate up to 1200 l/h. Connector 3/4".	<input type="checkbox"/>

■ Included in delivery. Available accessories. ▲ Extension hose.

HD 6/11-4 M PLUS

1.524-938.0



		Order Number			Price	Description	
Fine-mesh water filter with adapter	8	4.730-102.0				Fine-mesh water filter, 125 µm, max. temperature 50°C. Protects the high-pressure cleaner from dirt particles contained in the water. Water flow rate up to 1200 l/h. Connection 3/4", with adapter, 1".	<input type="checkbox"/>

Included in delivery.
 Available accessories.
 Extension hose.

HD 6/11-4 M PLUS 1.524-938.0



		Order Number		Price	Description	
Backflow check valve						
Backflow preventer	9	2.641-374.0			To prevent detergent getting into the drinking water cycle in case of inlet at low-pressure. - hot water resistant up to 80 °C - tested according to IEC 60335-2-79 - integrated leakage protection	<input type="checkbox"/>
Other HP Accessories						
Starting current limiter	10	2.637-495.0			Reduces starting current in single-phase supply and protects line fuse.	<input type="checkbox"/>

■ Included in delivery. □ Available accessories. ▲ Extension hose.

HD 6/11-4 M PLUS

1.524-938.0



		Order Number	Flow rate					Price	Description	
Push-on washing brush										
Push-on wash brush, M 18 x 1.5	1	4.113-001.0							Push-on wash brush for universal use. Simply push on to lance. Connector: M 18 x 1.6.	<input type="checkbox"/>
Rotating washing brush										
Rotating wash brush for < 800 l/h machines, nylon bristles	2	4.113-004.0	500-800 l/h						The rotating wash brush gently removes fine dust and traffic film from all surfaces. Temperature resistant up to 60°C. (M 18 x 1.5, replaceable brush insert).	<input type="checkbox"/>
Rotating wash brush for > 800 l/h machines, nylon bristles	3	4.113-002.0	800-1300 l/h						Driven by water stream. Gently removes fine dust and traffic film from any surface. Temperature resistant up to 60°C, M 18 x 1.5 (replaceable brush insert).	<input type="checkbox"/>
Rotating wash brush for < 800 l/h machines, natural bristles	4	4.113-003.0	500-800 l/h							<input type="checkbox"/>
Rotating wash brush for > 800 l/h machines, natural bristles	5	4.113-005.0	800-1300 l/h							<input type="checkbox"/>

■ Included in delivery. □ Available accessories. ▲ Extension hose.